

ROBOTIC SURFACE

D92164

PROJECT	
TYPE	
NOTES	
QUANTITY	
DATE	

GENERAL

Series: Robotic
 Brand: Milan
 Division: Design
 Mounting Type: Surface
 Mounting Location: Ceiling
 Subcategory: Spots

PHYSICAL

Shape: Cylinder
 Length (mm): 90
 Length (in): 3 ⁹/₁₆"
 Width (mm): 50
 Width (in): 1 ¹⁵/₁₆"
 Height (mm): 90
 Height (in): 3 ⁹/₁₆"
 Light Distribution: Adjustable / Direct
 Weight (kg): 1.8
 Weight (lbs): 4
 Fixture Finish: WHI
 Fixture Material: Metal

ELECTRICAL

Number of Lamps: 1
 Lamp Type: LED
 Total Output Wattage (W): 6.6
 Dimming: Non-Dimmable
 Driver Included: Yes
 Driver Location: Integrated
 Driver Type: Constant Current
 Driver Class: Class 2
 Input Voltage (V): 120
 Constant Current (mA): 350
 Upon Request: Dimmable option available with remote driver upon request

LED

Number of LEDs: 1
 Color Temperature (°K): 2700
 Max. Delivered Lumen (lm): 431.51
 Nominal Lumen (lm): 600
 CRI: >80 CRI

OPTICAL

RATINGS AND CERTIFICATIONS

Certified By: CSA Certified to UL and CSA Standards
 IP rating: IP20



108mm 4 1/4"



108mm 4 1/4"

J-Box cover plate
Included

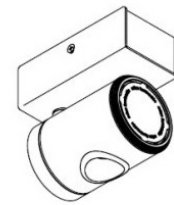

90mm 3 9/16"

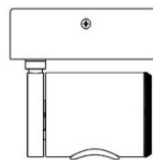

90mm 3 9/16"

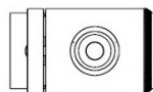

50mm 1 15/16"

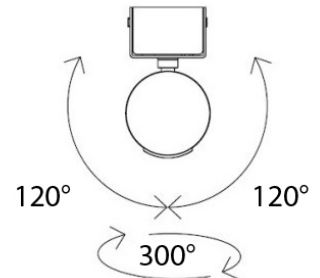

ROBOTIC SURFACE

D92166

PROJECT	
TYPE	
NOTES	
QUANTITY	
DATE	

GENERAL

Series: Robotic
 Brand: Milan
 Division: Design
 Mounting Type: Surface
 Mounting Location: Ceiling
 Subcategory: Spots

PHYSICAL

Shape: Rectangle
 Diameter (mm): 60
 Diameter (in): 2 3/8
 Length (mm): 138
 Length (in): 5 7/16
 Width (mm): 80
 Width (in): 3 1/8
 Height (mm): 144
 Height (in): 5 11/16
 Light Distribution: Adjustable / Direct
 Weight (kg): 1.8
 Weight (lbs): 4
 Fixture Finish: WHI
 Fixture Material: Metal

ELECTRICAL

Number of Lamps: 2
 Lamp Type: LED
 Total Output Wattage (W): 13.2
 Max. Wattage Per Lamp (W): 6.6
 Dimming: Non-Dimmable
 Driver Included: Yes
 Driver Location: External
 Driver Type: Constant Current
 Driver Class: Class 2
 Input Voltage (V): 120
 Lamp Voltage (V): 120
 Constant Current (MA): 2 x 175
 Upon Request: Dimmable option available with remote driver upon request

LED

Number of LEDs: 2
 Color Temperature (°K): 2700
 Max. Delivered Lumen (lm): 2 x 431.54
 Nominal Lumen (lm): 2 x 800
 CRI: >80 CRI

OPTICAL

Adjustability: Tilting and rotating

RATINGS AND CERTIFICATIONS

Certified By: CSA Certified to UL and CSA Standards
 IP rating: IP20

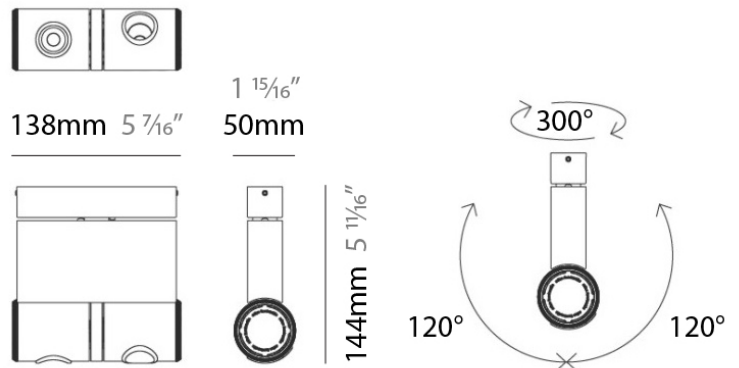
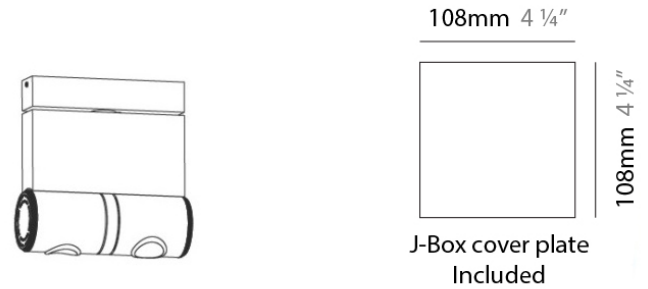

ROBOTIC SURFACE

D93202

PROJECT	
TYPE	
NOTES	
QUANTITY	
DATE	

GENERAL

Series: Robotic
 Brand: Milan
 Division: Design
 Mounting Type: Surface
 Mounting Location: Wall
 Subcategory: Uplight

PHYSICAL

Shape: Cylinder
 Diameter (mm): 50
 Diameter (in): 1 ¹⁵/₁₆
 Length (mm): 138
 Length (in): 5 ⁷/₁₆
 Height (mm): 116
 Height (in): 4 ⁹/₁₆
 Extension (mm): 115
 Extension (in): 4 ¹/₂
 Light Distribution: Adjustable / Direct
 Weight (kg): 1.8
 Weight (lbs): 4
 Fixture Finish: WHI
 Fixture Material: Metal

ELECTRICAL

Number of Lamps: 2
 Lamp Type: LED
 Total Output Wattage (W): 13.2
 Max. Wattage Per Lamp (W): 6.6
 Dimming: Non-Dimmable
 Driver Included: Yes
 Driver Location: Integrated
 Driver Type: Constant Current
 Driver Class: Class 2
 Input Voltage (V): 120
 Constant Current (MA): 500 [2 x 250 parallel wiring]
 Upon Request: Dimmable option available with remote driver upon request

LED

Number of LEDs: 2
 Color Temperature (°K): 3000
 Max. Delivered Lumen (lm): 2 x 800
 CRI: >80 CRI

OPTICAL

Optic°: 47

RATINGS AND CERTIFICATIONS

Certified By: CSA Certified to UL and CSA Standards
 IP rating: IP20

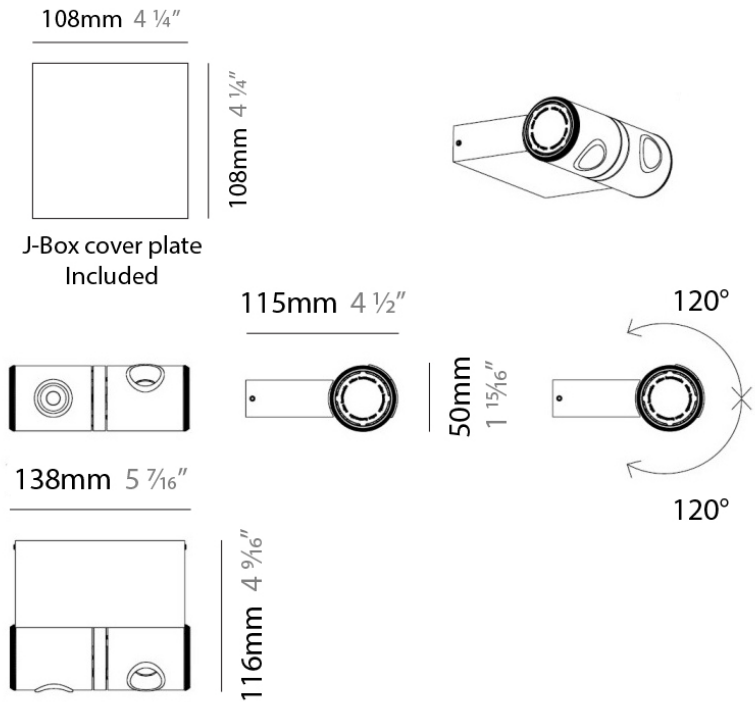

ROBOTIC RECESSED

D96022

PROJECT	
TYPE	
NOTES	
QUANTITY	
DATE	

GENERAL

Series: Robotic
 Brand: Milan
 Division: Design
 Mounting Type: Recessed
 Mounting Location: Ceiling

PHYSICAL

Shape: Round
 Diameter (mm): 80
 Diameter (in): 3 1/8
 Height (mm): 53
 Height (in): 2 1/16
 Light Distribution: Direct
 Weight (kg): 1.81
 Weight (lbs): 4
 Fixture Finish: WHI
 Fixture Material: Metal

ELECTRICAL

Input Wattage Range: 1 - 9 W
 Lamp Type: LED
 Total Output Wattage (W): 6.6
 Dimming: Non-Dimming / Phase Dimming (120Vac only) / 0-10V Dimming
 Driver Included: No
 Driver Location: Remote
 Driver Type: Constant Current - 120 / 277Vac
 Driver Class: Class 2
 Input Voltage (V): 120 - 277
 Constant Current (mA): 350

LED

Number of LEDs: 1
 Color Temperature (°K): 2700
 Max. Delivered Lumen (lm): 463
 Nominal Lumen (lm): 600
 CRI: >80 CRI
 Lamp Life (hrs): 50000

OPTICAL

Reflector°: 47

RATINGS AND CERTIFICATIONS

Certified By: CSA Certified to UL and CSA Standards
 IP rating: IP20

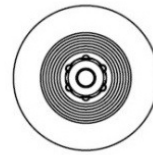

Ø80mm 3 1/8"

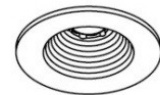

Ø60mm 2 3/8"

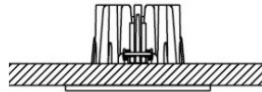

53mm
2 1/16"

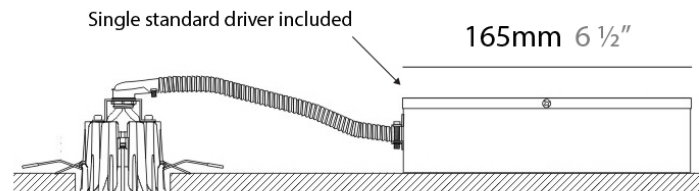

D

Single standard driver included

165mm 6 1/2"

38mm
1 1/2"











LEGEND

	floor-mounted		pivotal		special LED (upon request) RGB, RGBW, tunable, gold+, meat+, art+, fashion+
	wall and ceiling: recessed and surface mounted		rotating		warm dim / natural dimming LED
	ceiling-mounted and wall-mounted		illuminate tilted		rechargeable battery powered
	wall-mounted		color of suspension cable		fixture with natural vivid LED (upon request)
	omni-directional light distribution		length of suspension cable		color rendering index
	direct light distribution		reflector degree selection		color temperature
	direct/indirect light distribution		super spot		lumen (luminous flux)
	indirect light distribution		lens		efficacy (lumens per watt)
	asymmetric light distribution		lens pack		Unified Glare Rating (UGR) range from 5-40
	aura light distribution		shine ring		marine grade (AISI 316 stainless steel)
	round wall or ceiling cut-out		integrated shine ring with diffuser		walk on
	square wall or ceiling cut-out		free individual colors 01-29		drive on
	the supplied jig specifies the cutout dimensions		individual colors: 00 (free of charge), 01-25 (extra charge)		Dark Sky Compliance
	minimum distance (meters) lamp - object		luminaire part to be colored (F1)		Americans with Disabilities Act (less than 4" off the wall located between 27"-84" from floor)
	recessed depth		luminaire part to be colored (F2)		lamp protected against explosion
	ceiling thickness in mm		luminaire part to be colored (F3)		blown glass using traditional methods by master glass blower
	ceiling thickness selection		luminaire part to be colored (F4)		acoustic material
	dimmable DP (phase), DV (0-10V), DD (dali), DS (step-dim)		luminaire part to be colored (F5)		protection class I, protection insulation
	included or excluded LED driver/transformer/control gear		color of 3-circuit adaptor		protection class II, protection insulation
	separately switchable		indirect diffuser		ETL Certified to UL and CSA Standards
	sensor		direct diffuser		UL Certified to UL and CSA Standards
	remote control		ball-proof (upon request)		CSA Certified to UL and CSA Standards
	available upon request		accessory		Certified for North American Standards

IP RATING

	protected against ingress of solid bodies greater than 12.5mm (finger)
	protected against ingress of solid bodies greater than 2.5mm protected against sprays of water up to 60 degrees from the vertical (rain)
	protected against ingress of solid bodies greater than 1mm (wire) no protection against the ingress of moisture
	protected against ingress of solid bodies greater than 1mm (wire) protected against sprays of water up to 60 degrees from the vertical (rain)
	protected against ingress of solid bodies greater than 1mm (wire) protected against water splashed from all directions
	protected against limited ingress of dust (wet rooms/covered outdoor areas) protected against water splashed from all directions
	protected against ingress of dust protected against jets of water
	protected against ingress of dust protected against powerful jets of water or heavy seas
	protected against ingress of dust protected against immersion of water between 15cm - 1m for 30 minutes
	protected against ingress of dust protected against immersion of water under pressure for long periods

IK RATING

	protected against 0.14 joules impact (equivalent to 0.25kg mass dropped from 56mm above the surface)
	protected against 0.2 joules impact (equivalent to 0.25kg mass dropped from 80mm above the surface)
	protected against 0.35 joules impact (equivalent to 0.25kg mass dropped from 140mm above the surface)
	protected against 0.5 joules impact (equivalent to 0.25kg mass dropped from 200mm above the surface)
	protected against 0.7 joules impact (equivalent to 0.25kg mass dropped from 280mm above the surface)
	protected against 1 joules impact (equivalent to 0.25kg mass dropped from 400mm above the surface)
	protected against 2 joules impact (equivalent to 0.5kg mass dropped from 400mm above the surface)
	protected against 5 joules impact (equivalent to 1.7kg mass dropped from 300mm above the surface)
	protected against 10 joules impact (equivalent to 5.0kg mass dropped from 200mm above the surface)
	protected against 20 joules impact (equivalent to 5.0kg mass dropped from 400mm above the surface)